

## About the D-10-EC-STD

The Designer Series 10-EC is a suitable choice for ceiling heights up to 12 ft., providing an area of coverage of up to 500 sq. ft.

## D-10-EC-STD Control Types

The D-10-EC-STD uses an electrically commutated (EC) motor and can be controlled with a 0-10VDC signal.



## Velocity Profile

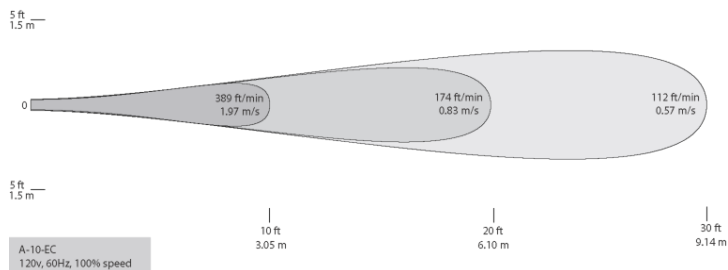

Data represents 80th percentile of 2000+ samples collected via hot wire anemometer recorded horizontally

## Alternative Fan Models (Similar to D-10-EC-STD-100-130-W)

Alternative Body Styles: Air Pear, Designer Series, Suspended Series

Alternative Sizes: 10, 15, 25, 45, 60

Alternative Motors: EC, SP

Alternative Nozzles: STD, SH

Alternative Voltages: 120V, 230V

Alternative Colors: Off White, Custom

## Contact

811 S. Sherman St., Longmont, CO 80501

Web: [airiusfans.com](http://airiusfans.com)

Phone: 888-AIR-PEAR (247-7327)

Fax: 303-772-8276

## Product Description

Airius fans create uniform air temperatures from floor to ceiling for thermal comfort and energy savings.

**Housing:** Aluminum, 5VA flame resistance. Off White

**Motor:** Electrically commutated, thermally-protected axial motor by ebm-papst®, 92% efficient. Operating temperature: -22°F (-30°C) to 122°F (50°C)

**Stator:** Patented multi-vane stator significantly increases air throw for maximizing performance.

**Certification:** Conforms to UL-507, CAN/CSA-C22.2 No. 1113, UL 94 5VA and is ETL listed in USA and Canada

**Warranty:** 3 years parts and workmanship. Money back guarantee: 30 days. Refurbishment program after 3-year warranty period.

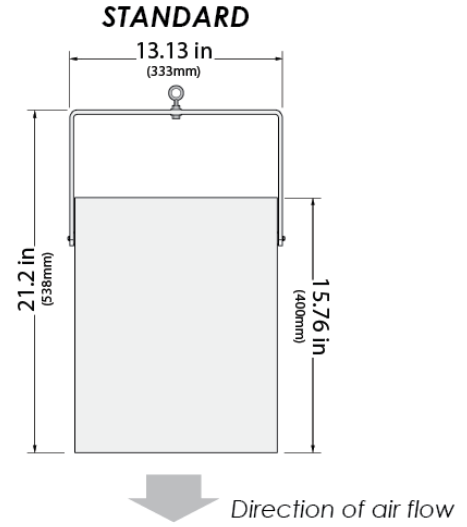

## Maximum Ratings

Model	Input Power, 1Ø	Amps	Watts	RPM	dB(A)	Mounting Height	Coverage Area
D-10-EC-STD	100-130VAC, 60Hz	0.11	13.0	1070	58.0	Up to 12 ft.	Up to 500 sq. ft.

<sup>(1)</sup>dB as Sound Power Level, designed to meet ISO 3744 - engineering grade precision for determining sound power.  
Data independently verified by third party. Tests performed in-unit.

## Controls & Factory Installed Options

Item #	Description
EC-MOD	Required for 0-10V control of this fan. Incompatible with PHI cells.
Pearlink	Wi-Fi iOS/Android controller
POT-1	Wall-mounted speed control
PHI-9-C	9" Photohydroionization cell to mitigate mold, bacteria, viruses, and odors
GUARD25	Phosphated steel grille coated in black plastic

Fan Config: D-10-EC-STD-100-130-W	QTY:
Controls/Options:	QTY:
Project:	Engineer:
Submitted By:	Architect:
Date:	Contractor: