

## About the D-15-SP-STD

The Designer Series 15-SP is a suitable choice for ceiling heights up to 18 ft., providing an area of coverage of up to 800 sq. ft.

## D-15-SP-STD Control Types

The D-15-SP-STD uses a shaded pole (SP) motor and can be controlled using a wall-mounted TRIAC speed control in-line with the fan power circuit or a 'smart' controller that accepts 0-10VDC, 2-20mA, or automatic Delta-T control signal.



## Velocity Profile

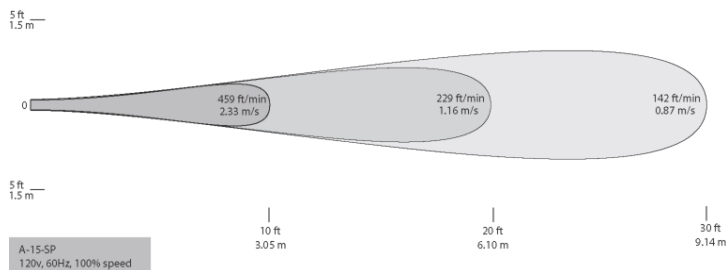

Data represents 80th percentile of 2000+ samples collected via hot wire anemometer recorded horizontally

## Alternative Fan Models (Similar to D-15-SP-STD-120-W)

Alternative Body Styles: Air Pear, Designer Series, Suspended Series

Alternative Sizes: 10, 15, 25

Alternative Motors: EC, SP

Alternative Nozzles: STD, SH

Alternative Voltages: 120V, 230V

Alternative Colors: Off White, Custom

## Contact

811 S. Sherman St., Longmont, CO 80501

Web: [airiusfans.com](http://airiusfans.com)

Phone: 888-AIR-PEAR (247-7327)

Fax: 303-772-8276

## Product Description

Airius fans create uniform air temperatures from floor to ceiling for thermal comfort and energy savings.

**Housing:** Aluminum, 5VA flame resistance. Off White

**Motor:** Single phase, shaded pole, single/variable speed, thermally-protected axial motor. Operating temperature: -4°F (-20°C) to 158°F (70°C). No lubrication required. Bearings are sealed.

**Stator:** Patented multi-vane stator significantly increases air throw for maximizing performance.

**Certification:** Conforms to UL-507, CAN/CSA-C22.2 No. 1113, UL 94 5VA and is ETL listed in USA and Canada

**Warranty:** 3 years parts and workmanship. Money back guarantee: 30 days. Refurbishment program after 3-year warranty period.

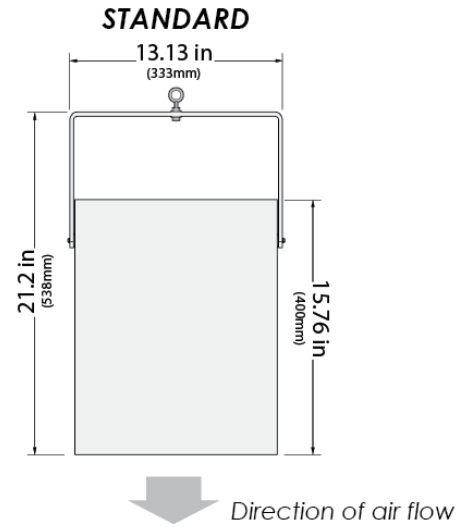

## Maximum Ratings

Model	Input Power, 1Ø	Amps	Watts	RPM	dB(A)	Mounting Height	Coverage Area
D-15-SP-STD	120VAC, 60Hz	0.18	17.6	1057	47.3	Up to 18 ft.	Up to 800 sq. ft.

<sup>(1)</sup>dB as Sound Power Level, designed to meet ISO 3744 - engineering grade precision for determining sound power.  
Data independently verified by third party. Tests performed in-unit.

## Controls & Factory Installed Options

Item #	Description
TRIAC-SMART-7.5	0-10VDC, 2-20mA, or fixed speed. Max 41 fans.
TRIAC-SMART-7.5-AUTO	Temperature control, 0-10VDC, 2-20mA, or fixed speed. Max 41 fans.
TRIAC-120-15	Manual wall-mounted speed control, 15A. Max 83 fans.
TRIAC-120-5	Manual wall-mounted speed control, 5A. Max 27 fans.
TRIAC-120-1.5	4-step, wall-mounted speed control, 1.5A with circuitry to reduce motor hum. Max 8 fans.
PHI-9-C	9" Photohydroionization cell to mitigate mold, bacteria, viruses, and odors
GUARD25	Phosphated steel grille coated in black plastic

Fan Config: D-15-SP-STD-120-W	QTY:
Controls/Options:	QTY:
Project:	Engineer:
Submitted By:	Architect:
Date:	Contractor: